

# Specification

## Planar Neon Series NMT1312-Plus

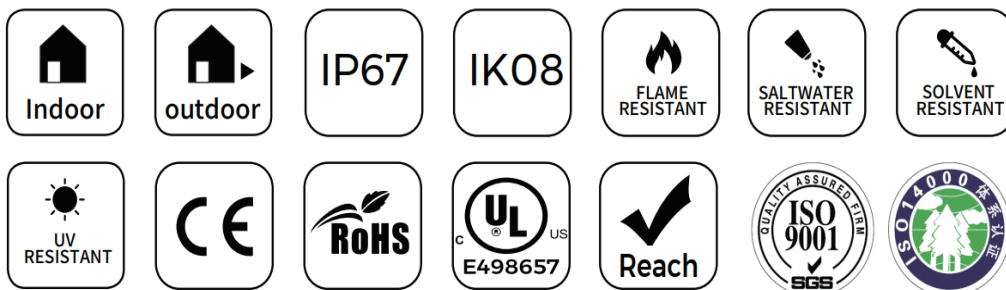

▼ **Features**



- ※ Light source: High luminous efficiency , LM80 test proved.
- ※ Process & Material: High light transmittance, food-grade environmental silicone material, integrated extrusion molding technology, IP67.
- ※ Optical Design: Unique optical light distribution structure design, uniform lighting surface and no shadow.
- ※ Appearance Design: Compared with the traditional neon tube or PVC guardrail tube, the silicone material has good flexibility, the simple and stylish appearance, which is exquisite and unique.
- ※ Product Certification: UL、 CE、 ROHS.
- ※ Environmental Features: Resistance to saline solutions, acids & alkali, corrosive gases and UV.
- ※ Working/Storage Temperature: Ta:-20~55°C / 0°C ~ 60°C.
- ※ Life Span: 36000H, 3 years warranty .



▼ **Product Application**

- ※ Signage Lighting
- ※ Outdoor/indoor decorative
- ※ Architectural Contour lighting

▼ **Product Bending Application**

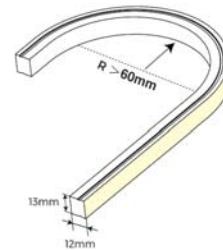

▼ **Product's protective technology & structure size**

**silicone end cap**

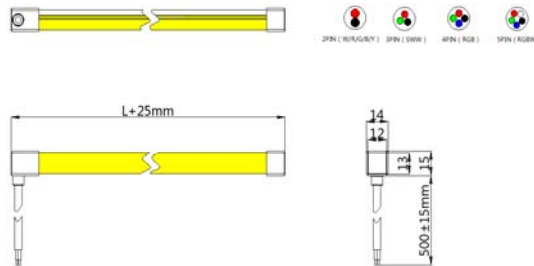

**Shadowless End-Cap**

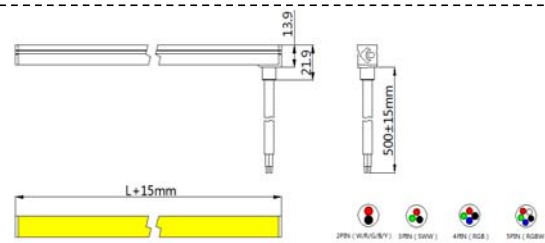

**full protective End-Cap**

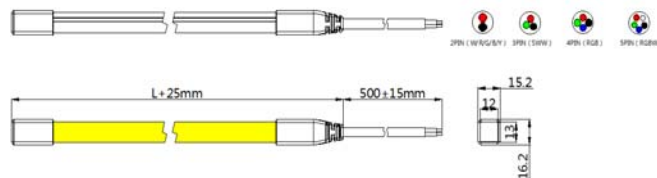

**Weld-free waterproof End-Cap**

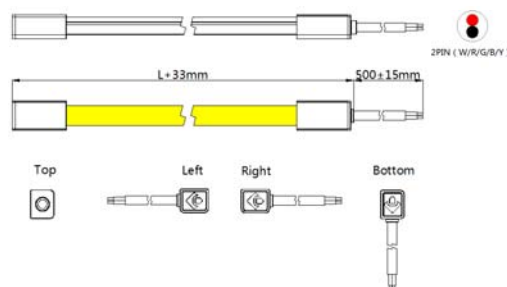
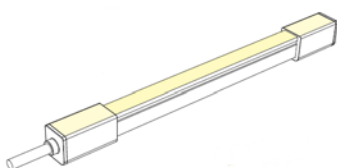

### ▼ Basic Parameters

Model	CCT/colors	CRI	Input voltage (V)	Rated current (A)	Rated power (w)	Lumens (LM)	Size (mm)	Max.length	Cutting unit (mm)	
NMT1312-XXX24CXN050XCXXX-Plus	2300K	>80/90	24V	0.4	9.6	640	W13*H12	5000&10000mm	50	
	2700K					640				
	3000K					670				
	4000K					670				
	5000K					670				
NMT1312-0X24CXN050XCXXX-Plus	R 620-630nm	/		0.34	8	/		W13*H12	5000 mm	62.5
	G 525-530nm					/				
	B 465-470nm					/				
	Y 587-592nm					/				
NMT1312-0RGB24CXN050XC0500-Plus	RGB	/		0.5	12	/		W13*H12	5000 mm	83
	R 620-630nm		/							
	G 525-530nm		/							
NMT1312-0RGBXX24CXN050XC0500-Plus	RGB~2300K	/	0.6	14.4	/	W13*H12	5000 mm	62.5		
	RGB~2700K				/					
	RGB~3000K				/					
	RGB~3500K				/					
	RGB~4500K				/					
NMT1312-95WDW24CXN050XC0500-Plus	RGB~5000K	>90	0.5	12	650	W13*H12	5000 mm	31.25		
	2700~5000K				/					
					/					

Note :

1. The above data is the testing result of 1M standard product;
2. The power and lumens of output data can be vary up to ±10%;
3. he above parameters are all typical values ;

### ▼ Light Distribution

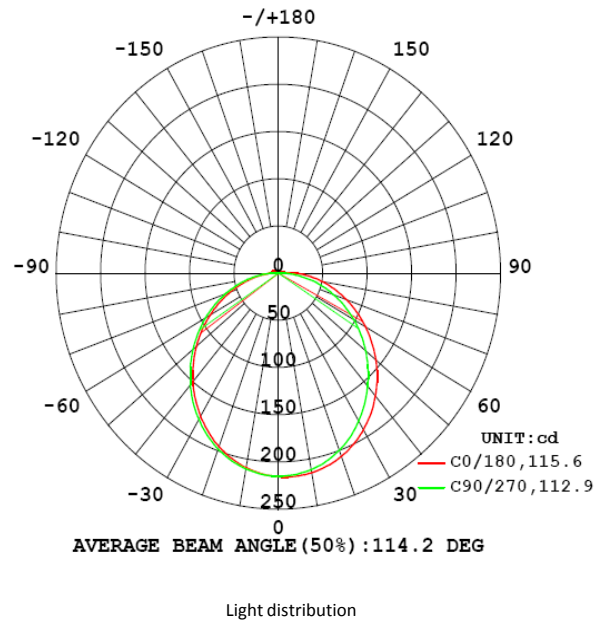
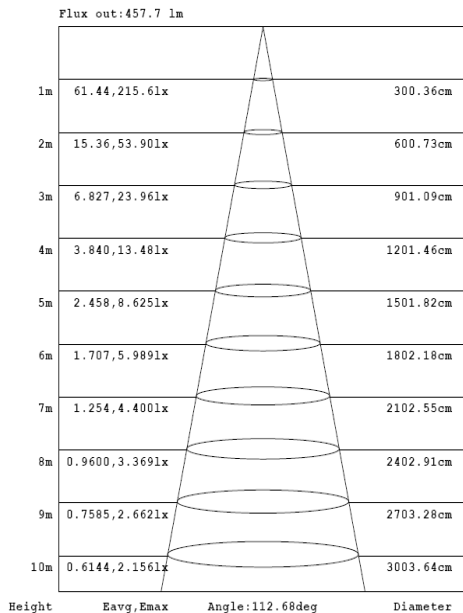

Note: The above data are based on the color temperature of 4000K monochrome. If you need other color IES files, please download the corresponding model from the IES database.



▼ Product System Solutions

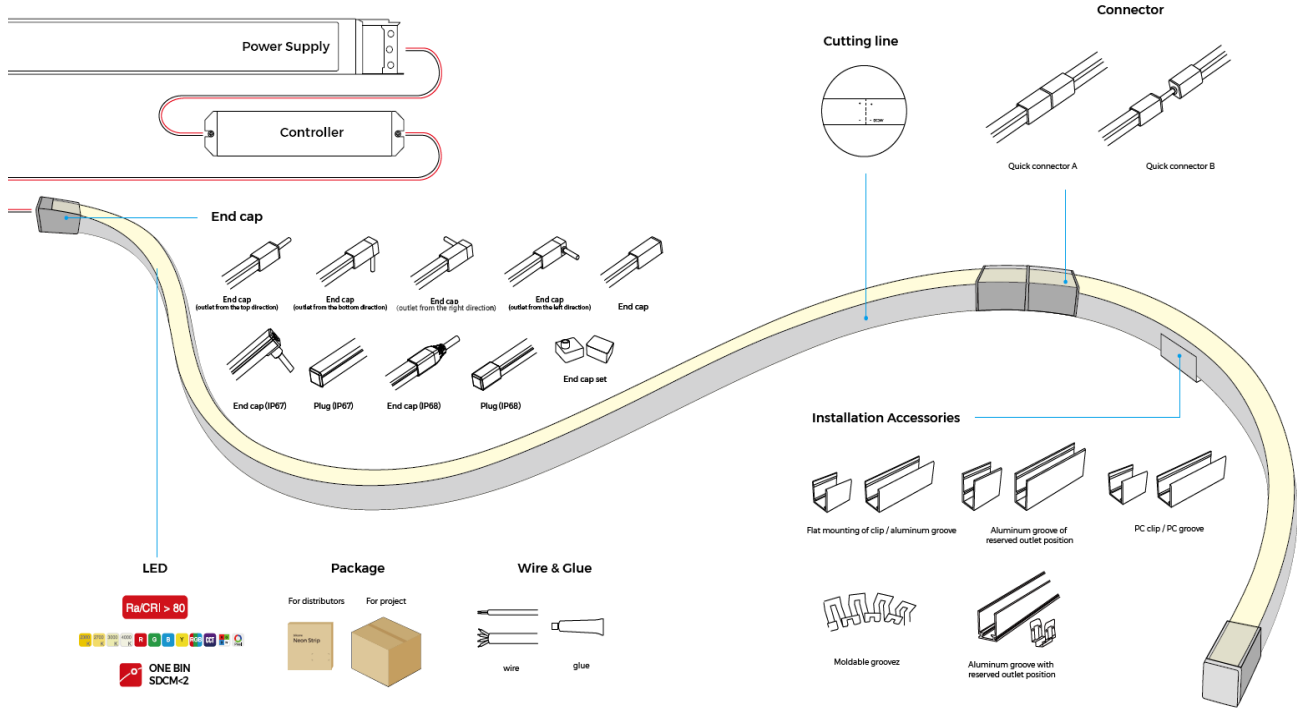

▼ Accessory information





Name	Description	Image	Sectional size	Ordering code	Product quantity/box (PCS)	Product quantity/box (kg)	Net weight per box (kg)	Gross weight (kg)	Gross weight (mm)	Remark
Aluminium carrier	Flat mounting aluminum groove			AS-NMT1312A-1000	30 PCS	0.1453	4.359	5.44	1100*112*50	Size : L1000*W15.4*H14.1mm, with screw
Aluminium clip	Flat mounting clip			AS-NMT1312A-25	450 PCS	0.0058	2.61	2.91	250*250*150	Size : L25*W15.4*H14.1mm, with screw
Aluminium carrier	Aluminum groove of reserved outlet position			AS-NMT1312A1-1000	24 PCS	0.1513	3.64	4.72	1290*112*50	Size : L1000*W15.4*H19.8mm, with screw
Aluminium clip	clip with reserved outlet position			AS-NMT1312A1-25	450 PCS	0.0061	2.745	3.045	250*250*150	Size : L25*W15.4*H19.8mm, with screw
Alumina carrier	Pre-installed aluminium groove			AS-NMT1312A2-1000	12	0.167	2	3.1	1290*112*50	Size : L1000*W16.6*H16.3mm with screws , 5 clips for 1 meter
PC carrier	Flat mounting PC groove			AS-NMT1312P-1000	30	0.066	1.98	3	1290*112*50	Size : L1000*W15.4*H14.6mm with screws
PC carrier	Flat mounting of PC clip			AS-NMT1312P-25	350	0.004	1.4	1.655	250*250*150	Size : L25*W15.4*H14.6mm with screws
Moldable carrier	Moldable groovez			AS-NMT1312M-500	66	0.046	4.55	6	500*290*290	Size : L500*W13.7*H13.5mm , with screw
End-Cap set	End cap set, including end cap and plug (outlet from the left direction)			AS-NMT1312G50-EC	400	0.0035	1.4	1.7	250*250*150	/
End-Cap set	End cap set, including end cap and plug (outlet from the top direction)			AS-NMT1312GH0-EC	400	0.0035	1.4	1.7	250*250*150	/
End-Cap set	End cap set, including end cap and plug (outlet from the bottom direction)			AS-NMT1312GD0-EC	400	0.0035	1.4	1.7	250*250*150	/



Weld-free waterproof End-Cap	Quick connector(outlet from the top direction)			AS-NMT1312HT0-FL	48	0.04	1.92	3.735	365x365x190	outlet 500mm\IP67
Weld-free waterproof End-Cap	Quick connector(outlet from the bottom direction)			AS-NMT1312HB0-FL	48	0.04	1.92	3.735	365x365x190	outlet 500mm\IP67
Weld-free waterproof End-Cap	Quick connector(outlet from the left direction)			AS-NMT1312HL0-FL	48	0.04	1.92	3.735	365x365x190	outlet 500mm\IP67
Weld-free waterproof End-Cap	Quick connector(outlet from the right direction)			AS-NMT1312HR0-FL	48	0.04	1.92	3.735	365x365x190	outlet 500mm\IP67
Weld-free waterproof End-Cap	Quick connector(plug)			AS-NMT1312TX0-FL	48	0.03	1.44	3.255	365x365x190	IP67
Weld-free waterproof connector	Quick connector(without wire)			AS-NMT1312MX0-FL	96	0.026	2.496	2.75	365x365x190	IP67
Weld-free waterproof connector	Quick connector(with wire)			AS-NMT1312MH0-FL	48	0.053	2.544	2.8	365x365x190mm	middle wire 300mm , IP67
Glue	Acid glue		/	AS-PG-0002	150	0.014	2.1	2.4	250*250*150	10ml/pcs
wire	2P PVC wire ( 0.5M )		/	AS-WS-0001	150	0.01541	2.31	2.61	250*250*150	Suitable for single color strip
wire	2P PVC wire ( 2M )		/	AS-WS-0002	125	0.0616	7.7	8	250*250*150	Suitable for single color strip
wire	4P PVC wire ( 0.5M )		/	AS-WS-0003	150	0.0194	2.91	3.21	250*250*150	Suitable for RGB strip Suitable for SWW strip
wire	4P PVC wire ( 2M )		/	AS-WS-0004	125	0.0776	9.7	10	250*250*150	Suitable for RGB strip Suitable for SWW strip
wire	5P PVC线材 wire ( 0.5M )		/	AS-WS-0013	150	0.0195	2.925	3.364	250*250*150	Suitable for RGB strip
wire	5P PVC wire ( 2M )		/	AS-WS-0014	125	0.0755	9.4375	10.86	250*250*150	Suitable for RGB strip
connector	2PIN IP68 Waterproof connector		/	AS-FC-0001	512	0.016	8.192	9.5	365*365*190	Suitable for single color strip
connector	3PIN IP68 Waterproof connector		/	AS-FC-0002	512	0.018	9.216	10.2	365*365*190	Suitable for SWW strip
connector	4PIN IP68 Waterproof connector		/	AS-FC-0003	288	0.03	8.64	9.6	365*365*190	Suitable for RGB strip Suitable for RGBX strip



## ▼ Product Control System Solution

Name	Model	Ordering code	Parameters	Dimming constant-voltage acceptor	Suitable products
 Single color dimming set	M1+M4-5A	23-01-00-0045	Operating voltage: 3VDC (Battery CR2032) Operating frequency: 433.92MHz Remote control distance: 30m Operating temperature: -30°C 55°C	Input voltage: 12-24VDC Maximum loaded current: 5A*4CH Max 20A Maximum loaded power:240W/480W(12V/24V) Operating temperature: -30°C 55°C Size: L170*W44*H30(mm) Package size: L228*W155*H32(mm)	White color strip
 CCT set	M2+M4-5A	23-01-00-0005	Operating voltage: 3VDC (Battery CR2032) Operating frequency: 433.92MHz Remote control distance: 30m Operating temperature: -30°C 55°C	Input voltage: 12-24VDC Maximum loaded current: 5A*4CH Max 20A Maximum loaded power:240W/480W(12V/24V) Operating temperature: -30°C 55°C Size: L170*W44*H30(mm) Package size: L228*W155*H32(mm)	SWW dual CCT LED strip
 RGB set	M3+M4-5A	23-01-00-0046	Operating voltage: 3VDC (Battery CR2032) Operating frequency: 433.92MHz Remote control distance: 30m Operating temperature: -30°C 55°C	Input voltage: 12-24VDC Maximum loaded current: 6A*3CH Max 18A Maximum loaded power:216W/432W(12V/24V) Operating temperature: -30°C 55°C Size: L170*W44*H30(mm) Package size: L228*W155*H32(mm)	RGB LED strip
 RGBW set	M4+M4-5A	23-01-00-0047	Operating voltage: 3VDC (Battery CR2032) Operating frequency: 433.92MHz Remote control distance: 30m Operating temperature: -30°C 55°C	Input voltage: 12-24VDC Maximum loaded current: 5A*4CH Max 20A Maximum loaded power : 240W/480W (12V/24V) Operating temperature: -30°C 55°C Size: L170*W44*H30(mm) Package size: L228*W155*H32(mm)	RGBW LED strip
 Independent digital controller	M16-SPI-16S	25-01-00-0041	(Parameters of remote controller) Operating voltage: 3VDC (Battery CR2032) Operating frequency: 2.4GHz Changing mode: 16 Operating temperature: -30°C 55°C	(Dimming constant-voltage acceptor) Input voltage: 5-24VDC Output: SPI WiFi: 2.4GHz Operating temperature: -30°C 55°C Product size: L135*W30*H20(mm) Package size: L132*W198*H22 (mm)	Professional for SPI digital LED strip

## ▼ Wiring Diagram

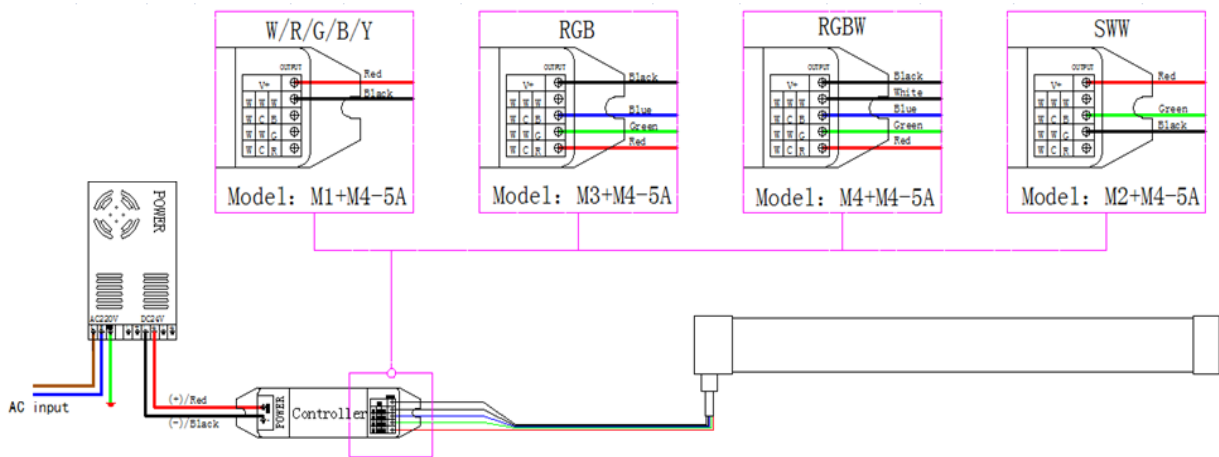

## ▼ Installation Guidance

### Installation of clip

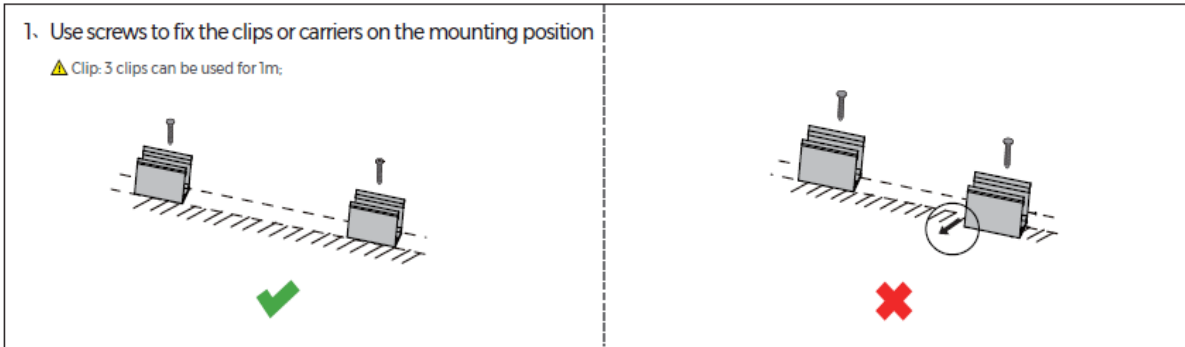

### Installation of carrier

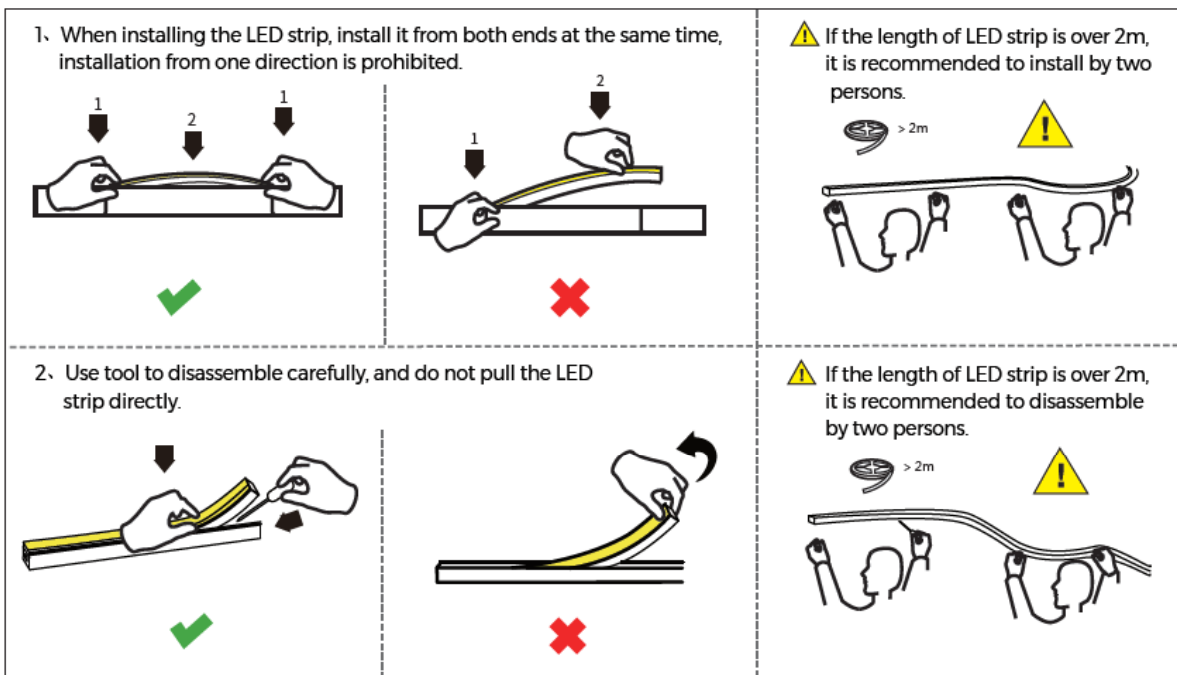

▼ Packaging Solutions

standard packaging

PN:NMT1312-Plus    PN:NMT1312-Plus  
Color:3000K        Color:3000K  
DC 24V                DC 24V

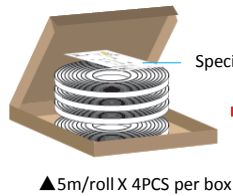

**OLORS**

NMT1312-Plus

Voltage: DC24V    Type: Silicon resin strip  
Power(Typ): 10.8W/m    Part NO: XXXXXXXXXX  
Power(Max): 9.6W/m    SO: T704016  
Color/CCT: 3000K    Size: 3000X13X12mm  
IP: IP67    Date: 20170401

www.colorsled.com    3000K

QTY:    PCS  
N.W:    KGS  
G.W:    KGS  
QC Date:20170503    No.: **20**

PN:NMT1312-Plus    PN:NMT1312-Plus  
Color:3000K        Color:3000K  
DC 24V                DC 24V

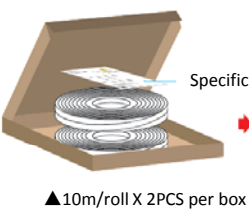

**OLORS**

NMT1312-Plus

Voltage: DC24V    Type: Silicon resin strip  
Power(Typ): 10.8W/m    Part NO: XXXXXXXXXX  
Power(Max): 9.6W/m    SO: T704016  
Color/CCT: 3000K    Size: 3000X13X12mm  
IP: IP67    Date: 20170401

www.colorsled.com    3000K

QTY:    PCS  
N.W:    KGS  
G.W:    KGS  
QC Date:20170503    No.: **20**

Model	Product size	Product Quantity/box	Product Quantity/case	Product net weight ( kg )	Net weight per box ( kg )	Gross weight ( kg )	Carton size ( M )
NMT1312-XXX24CSN050CCXXX-Plus	L5000*13*12mm	5M*4	80M	0.86	13.76	15.31	0.41*0.41*0.26M
	L10000*13*12mm	10M*2	80M	1.72	13.76	15.31	
NMT1312-0X24CSN050CCXXX-Plus	L5000*13*12mm	5M*4	80M	0.86	13.76	15.31	
	L10000*13*12mm	10M*2	80M	1.72	13.76	15.31	
NMT1312-0RGB24CSN050CC0500-Plus	L5000*13*12mm	5M*4	80M	0.86	13.76	15.31	
NMT1312-0RGBX24CSN050CC0500-Plus	L5000*13*12mm	5M*4	80M	0.86	13.76	15.31	
NMT1312-9SVDW24CSN050CC0500-Plus	L5000*13*12mm	5M*4	80M	0.86	13.76	15.31	





**Package for distributor**

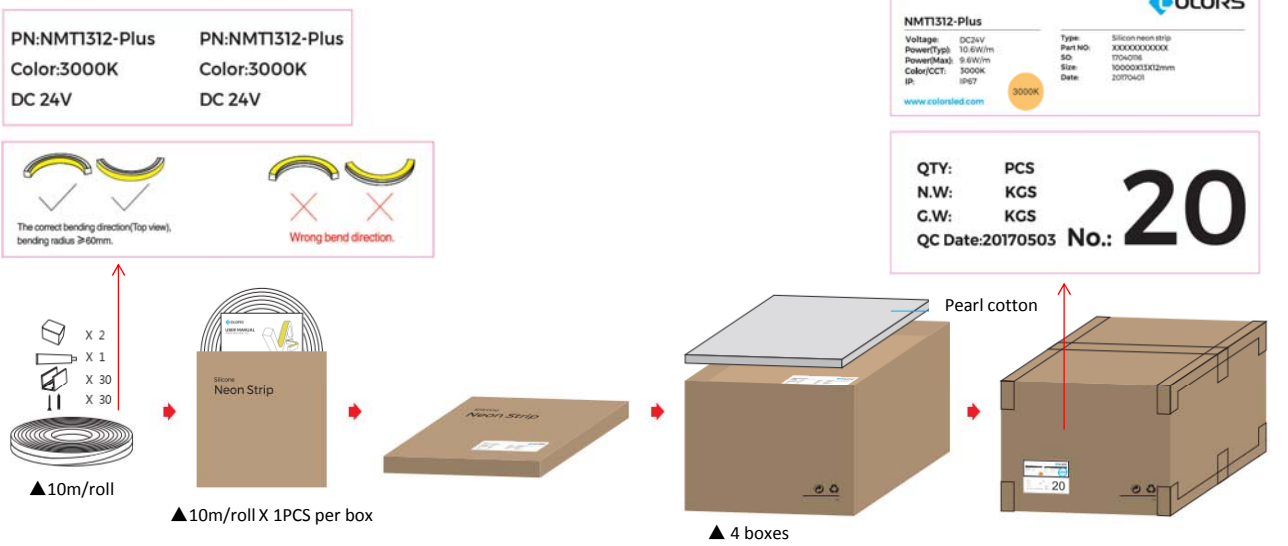
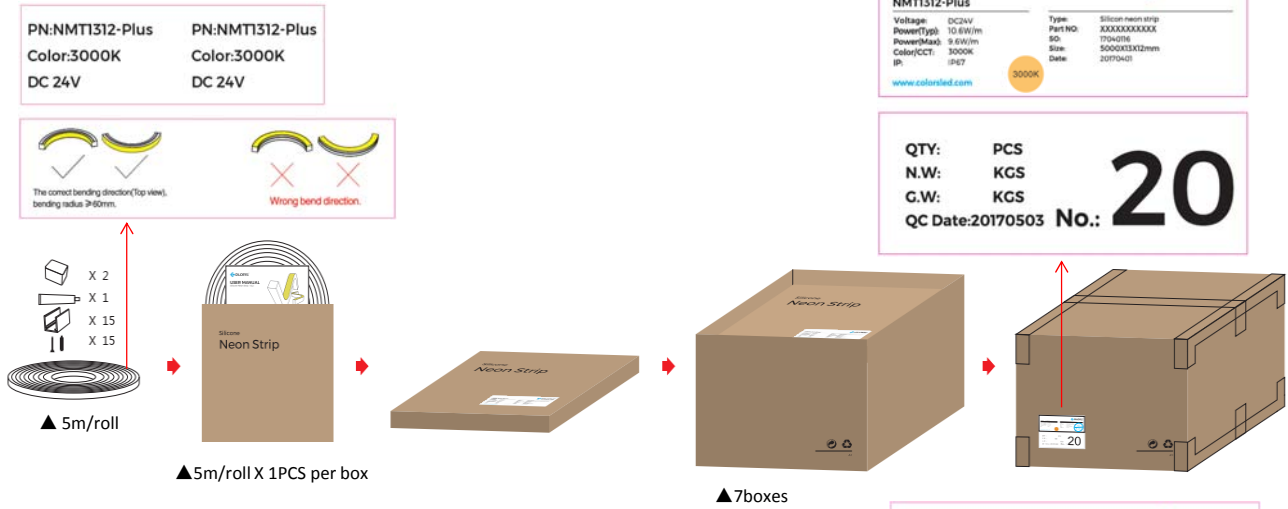

Model	Product size	Product Quantity/box	Product Quantity/case	Product net weight ( kg )	Net weight per box ( kg )	Gross weight ( kg )	Carton size ( M )
NMT1312-XXX24CDN050BC0500-Plus	L5000*13*12mm	5M*7	35M	0.91	6.16	8.15	0.365*0.365*0.19M
NMT1312-0X24CDN050BC0500-Plus							
NMT1312-0RGB24CDN050BC0500-Plus							
NMT1312-0RGBW24CDN050BC0500-Plus							
NMT1312-9SWDW24CDN050BC0500-Plus							
NMT1312-8XX24CDN050BC1000-Plus	L10000*13*12mm	10M*4	40M	1.72	6.9	8.75	0.365*0.365*0.19M
NMT1312-0X24CDN050BC1000-Plus							



▼ **Ordering Code**

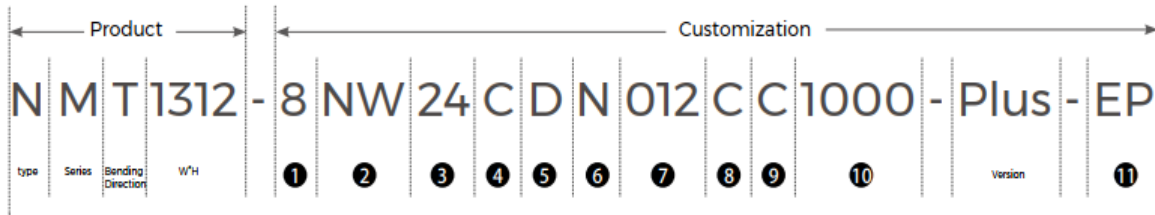

Simple steps, open to the outside world in an all-round way, customize personalized product

CRI	Code	1
RGB or colorful, no CRI	0	
CRI>80	7	
CRI>80	8	
CRI>90	9	

Silk Printing	Code	4
COLORS	C	
Neutral	N	
Customized	S	

COLORS	Code	8
COLORS	C	
Package for distributors	B	

CCT/color	Code	2
2200-2400K	LW	
2600-2800K	SW	
2800-3200K	WW	
3200-3800K	PW	
3800-4200K	NW	
4800-5200K	DW	
Red	R	
Green	G	
Blue	B	
Yellow	Y	
Adjustable CCT	SWW	
RGB	RGB	
RGBW	RGBW	
RGBX	RGBX	

Entry cable	Code	5
One end	S	
Dual-ends	D	
No	X	

Label Type	Code	9
COLORS	C	
Customized	S	

Wire Type	Code	6
PVC	N	
No wire	X	
Silicone wire	S	

Strip Length	Code	10
50m/reel	5000	
15m/reel	1500	
10m/reel	1000	
5m/reel	0500	

Wire Length	Code	7
50CM	050	
No wire	000	

IP	Code	11
IP67	EP	
IP67	NP	

Operating voltage	Code	3
DC5V	05	
DC12V	12	
DC24V	24	
DC48V	48	

Ordering example : NMT1312-8LW24NSS050CC0500-Plus-EP

Cambered Neon Series(top bend), Width \* height: 13 \* 12mm, 2835LED, CRI 80, CCT after glue: 2300K, DC24V, neutral silk printing, single-end 50CM silicone wire, with brand name, 5m/roll packaging, PLUS version, IP67 End-Cap



## ▼ Precautions

- Use a 24V DC isolated power supply to drive the neon lamp strip and the ripple wave of constant voltage source shall be less than 5%. It is not allowed to use RC voltage reduction or non-isolated power supply to drive the neon lamp strip.
- In actual applications, 20% of the power supply shall be kept (only 80% of the power is used) to guarantee that sufficient voltage is available to drive the product.
- Attention shall be paid to safe operation. After powering on, it is not allowed to touch the AC power supply to avoid an electric shock.
- Attention shall be paid to the positive and negative poles of the wires during installation and whether the power supply conforms to required voltages to avoid damages.
- Avoid scratching, distortion and irregular bending of the product during installation; otherwise it may cause irreparable damage to the product.
- Please do not bend the strip into an arc with a diameter less than 60mm to ensure the longevity and reliability, the bending diameter too small will damage the product itself.
- If the actual length of application exceeds the specified using length, it will lead to overload heating and uneven brightness.
- To keep the eyes from being harmed, try to avoid staring at the glowing side of the LED strip for a long time.
- Non-professionals are prohibited from installing, disassembling and repairing the product.
- Do not use any acid or alkaline adhesive to fix products (including not limited to glass cement, etc.)
- Product is not suitable for use in swimming pools and fountains.
- Please confirmed before usage as products of varied sizes show slight differences in their color under same color temperature due to their structural differences.
- When IP67 protective products are installed and applied, the waterproofing grade should be degraded after self-processing and cutting.

### Cutting method

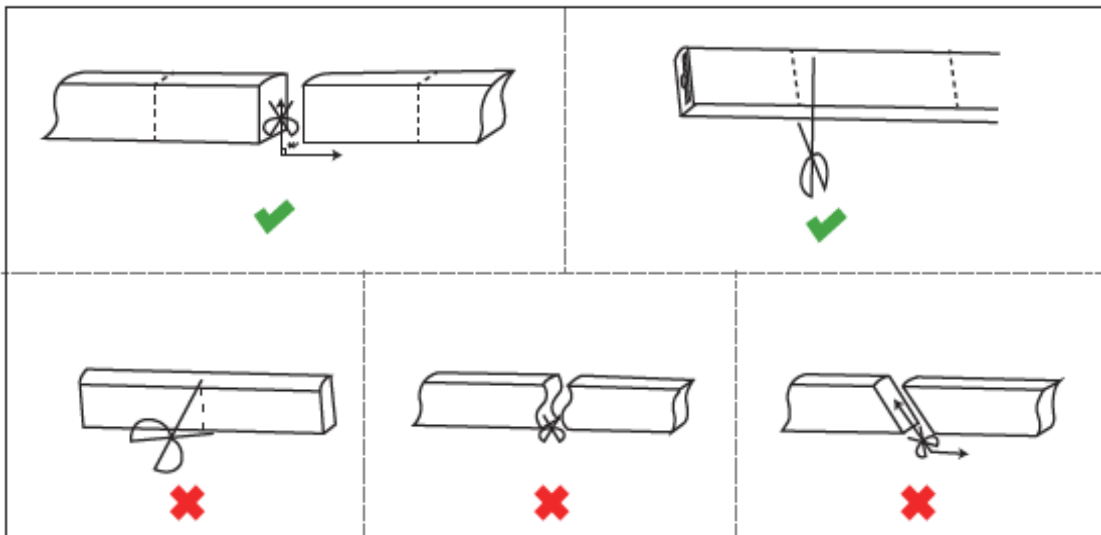

It is forbidden to wrap objects less than 60mm

